

# ASTRALPOOL

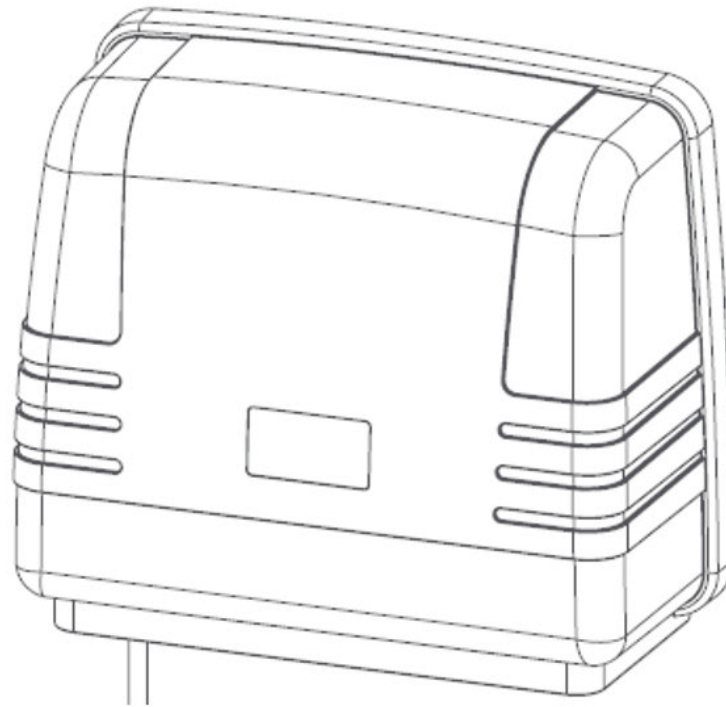

## INSTALLATION MANUAL



### HALO<sup>®</sup> HUB<sup>™</sup> AUTOMATION EXPANSION MODULE

#### WARNING

FOR YOUR SAFETY - This product must be installed in accordance with AS/NZ 3000 - 2018 and any other local applicable regulations. Before installing this product, read and follow all warning notices and instructions that accompany this product. Failure to follow warning notices and instructions may result in property damage, personal injury, or death. Improper installation and/or operation will void the warranty.

Improper installation and/or operation can create unwanted electrical hazard which can cause serious injury, property damage, or death.



For full warranty terms and conditions and to register your warranty, visit [www.astralpool.com.au/warranty](http://www.astralpool.com.au/warranty) and complete your details. Or scan the QR code to go directly to the registration page

Record your equipment details here for quick reference:

Model No. : \_\_\_\_\_

Serial No. : \_\_\_\_\_

### EQUIPMENT INFORMATION RECORD

DATE OF INSTALLATION \_\_\_\_\_

INSTALLER INFORMATION \_\_\_\_\_

LIGHTING CONTROLLER MODEL \_\_\_\_\_

SERIAL NUMBER \_\_\_\_\_

## TABLE OF CONTENTS

Section 1. Important Safety Instructions .....	4
Section 2. System Overview .....	5
2.1 Kit Contents.....	5
Section 3. Installation.....	5
3.1 Mounting .....	5
3.2 Power Connections .....	5
3.3 Other Connections .....	6
Section 4. Pairing and Configuring a Halo Hub .....	6
4.1 Pairing to the Halo Chlor .....	6
4.2 Configuration and Setup.....	8
4.3 Unpairing from a Halo Chlor .....	9
Section 5. Control using the Halo Chlor .....	9
5.1 Manual Control .....	9
5.2 Timer Control.....	9
Section 6. Control with the Chlorinator .....	10
6.1 Halo Chlor App.....	10
Section 7. Regular Maintenance .....	10
Section 8. Troubleshooting .....	10
Section 9. Appendices .....	10
9.1 Appendix 1: .....	10
9.2 Appendix 2: .....	10

## Section 1. Important Safety Instructions

### READ AND FOLLOW ALL INSTRUCTIONS

When installing and using this electrical equipment, basic safety precautions should always be followed, including the following:

#### **⚠ WARNING**

The Halo Hub has an IP23 rating, meaning it is suitable for installation outdoors. For safe operation, the Halo Hub must be installed in the correct orientation, with the cables leaving from the bottom of the device. If installing the Halo Hub near the pool or spa water, you must ensure that the rules of AS3136 are followed at all times. AstralPool strongly recommends that installation be performed by a registered pool builder, electrician or other suitably qualified person.

#### **⚠ WARNING**

**Risk of electric shock** - Install the controller at least 3.5 metres from the inside wall of the pool and/or hot tub using non-metallic plumbing.

#### **⚠ WARNING**

If the supply cord is damaged, it must only be replaced by AstralPool®, its service agent or a similarly qualified person, in order to avoid a hazard.



**SAVE THESE INSTRUCTIONS**

## Section 2. System Overview

The Halo Hub is designed to work in conjunction with a Halo Chlor and can be controlled through the Halo Chlor's main touchscreen or through the Halo ChlorGo App.

Only one Halo Hub can be paired to a Halo Chlor.

The Halo Hub is not designed to work in a "stand alone" mode and cannot be controlled unless it is paired to a Halo Chlor.

### Kit contents

Before starting, check that you have the correct parts as shown. If any parts are missing or incorrect, please call your local distributor or technical support at 1300 186 875 for assistance.

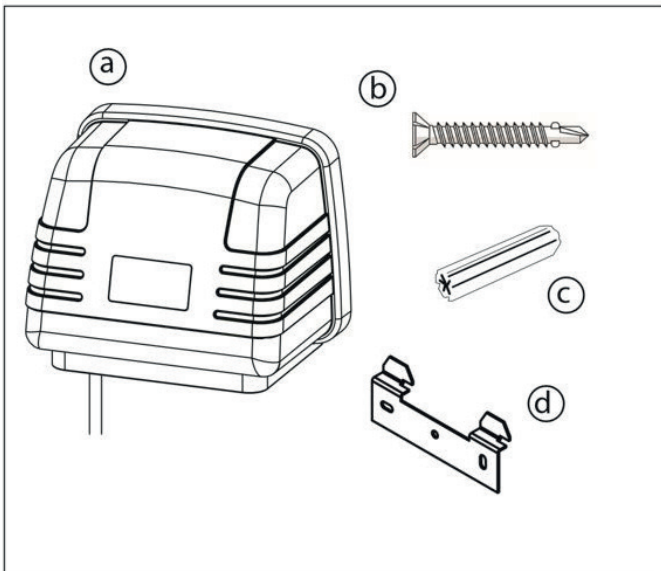

Halo Hub kit contents	
a.	Halo Hub controller
b.	Screws 8G 3/4 (2)
c.	Masonry plug 8G 25 mm (2)
d.	Mounting bracket

Figure 1. Kit Contents

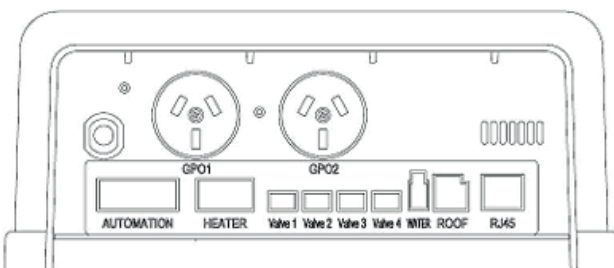

Figure 2. Base View

## Section 3. Installation

### 3.1 Mounting

The Halo Hub must be mounted to a wall using the steel mounting bracket supplied. The position of the mounting bracket, relative to the top of the product, which will aid in setting out the equipment area and aligning with other Halo products.

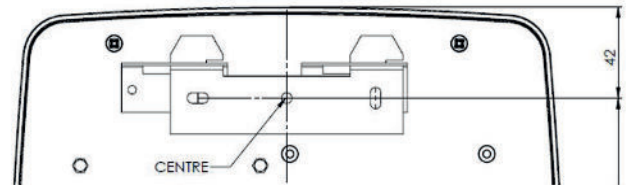

Figure 3. Power Supply Keyhole Mounting (back)

1. Identify a suitable installation location.

**NOTE:** The distance between the Halo Hub and the Halo Chlor should be less than 5 meters and ideally should be "line of sight" for a reliable connection.

If the chlorinator is housed in an equipment enclosure, then ideally the Halo Hub should also be located in the same enclosure.

If in doubt, test the signal strength using a mains power extension cord to pair the Halo Hub to the Halo Chlor before mounting the Halo Hub.

2. Insert the two mounting screws into the wall bracket, 85 mm apart. Use the two plastic masonry plugs (provided) if mounting into masonry.
3. Hang the Hub on the mounting bracket through the slots. Ensure the hub drops down into place. Slide to the right to lock in position.

### 3.2 Power Connections

Halo Hubs are provided with a 2.8Mtr power cable for connection to a mains outlet.

The Halo Hub has 2 mains power outlets (GPO 1 and GPO 2).

The following table indicates the maximum permitted current draw from each outlet.

	Mains GPO Type	Max Current (GPO 1)	Max Current (GPO 2)	Max Total (GPO1+2)
20382 Halo Hub	10A	9.5A	9.5A	9.5A

### 3.3 Other Connections

The Halo Hub can control up to 4 valves (Valve 1 ... Valve 4) and has two temperature sensor connectors (water and roof). (This is in addition to the temperature sensor connector on a connected Halo Chlor.)

It can also control an AstralPool Viron Heatpump through the RJ45 connector, or it can control a heater via a voltage free heater relay (heater connector).

In addition to this, there is provision to accept 2 low voltage inputs and control a low voltage relay (automation connector).

The use of the Halo Hub connections varies depending on the type of equipment connected. If your setup doesn't require a temperature sensor (e.g. garden lights), then these connections are ignored.

The following table shows typical uses for the two temperature sensors on the Halo Hub.

**NOTE:** The Halo Hub does not support the use of the filter pump for solar control.

Application	Purpose	Temp Sensor 1	Temp Sensor 2
Solar control	Separate solar pump used for solar	Water temperature	Roof temperature
Heater control (through GPO)	Main filter pump used for heater	N/A - use Halo Chlor water temperature sensor	N/A
Heater control (through GPO)	Separate pump used for heater	Water temperature	N/A
Heater control through the "Heater" connector, see Appendix 1	Main filter pump used for heater	N/A - Use Halo Chlor water temperature sensor	
Heater control through the "Heater" connector	Separate pump used for heater	Connect thermistor into "Heater Connector", see Appendix 1	

## Section 4. Pairing and Configuring a Halo Hub

Setting up Halo equipment is a two-part process. Firstly pair all of the devices and then configure the equipment that will be connected.

**NOTE:** Icons in the chlorinator app (bottom ribbon of the app screen and top ribbon on the chlorinator screen) may vary depending on what equipment is installed.

### 4.1 Pairing to the Halo Chlor

To pair a Halo Hub to a Halo Chlor:

1. Press the "settings" icon  (in the lower left corner) on the "HOME" page on the chlorinator.



2. Press the "INSTALL" icon in the top ribbon of the "Settings" page of the chlorinator.

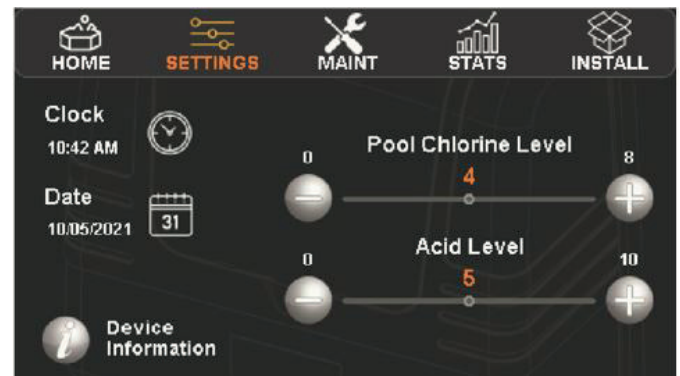

3. Press "Add Remove" in the "Equipment Configuration" area on the install page (lower left corner).

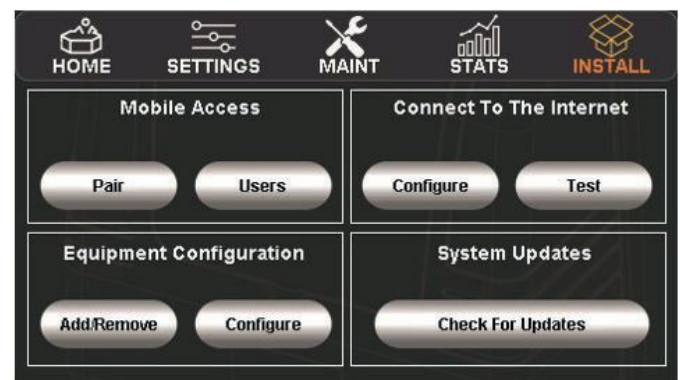

The list of "Connected Devices" shows devices that can be connected to the Halo Chlor. These are shown with the symbol to the right of the device name. In this case, press the symbol on the Halo Hub icon.

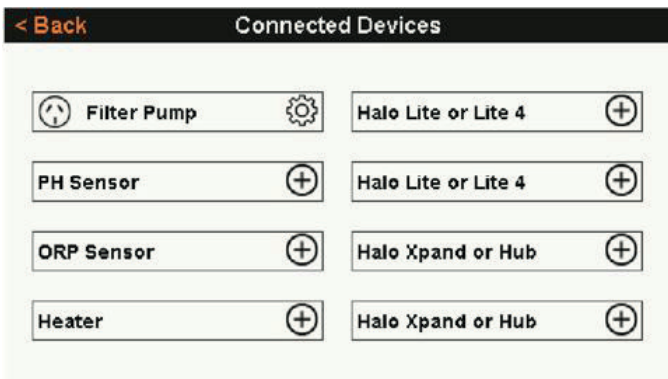

Follow the prompts, turn off the power to the Halo Hub for 3 seconds, then turn it back on.



If the signal strength is strong enough pairing will be automatic. After pairing, the signal strength is shown as a bar graph in the connected devices view: A signal of 2 "bars" or better is desirable for robust connections. If the signal displays 1 bar, consider moving the device closer to the Halo Chlor.

- Define what equipment you want to assign to each one of two GPO's. Press the button of the Halo Hub and press "Edit".



- On the next screen, enable or disable each GPO (outlet 1 and outlet 2) and define which equipment should be plugged into each outlet.

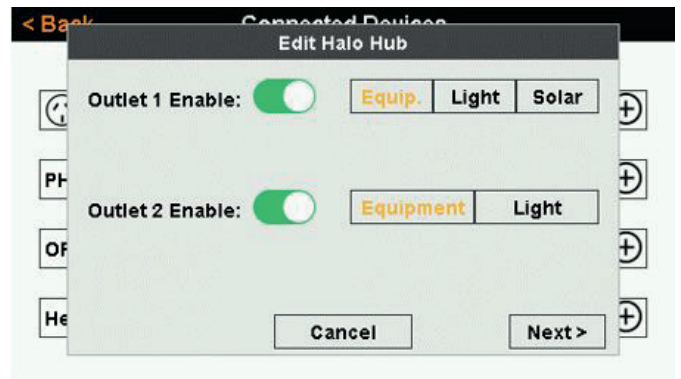

**NOTE:** – Solar pumps must use outlet 1.  
– If a heater is being controlled by a GPO, the heater unit must use outlet 1.

- To enable the use of valves or relays, press "Next" on the screen above and use the sliders to enable the features that you require.

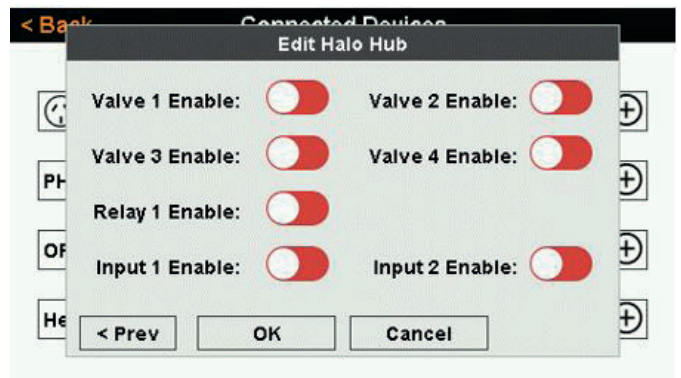

Press OK to leave this menu.

For information on the use of relay 1, and input 1 or 2, see Appendix 2.

If you are adding a heater, press the "Add/Remove" button and then press "Heater".

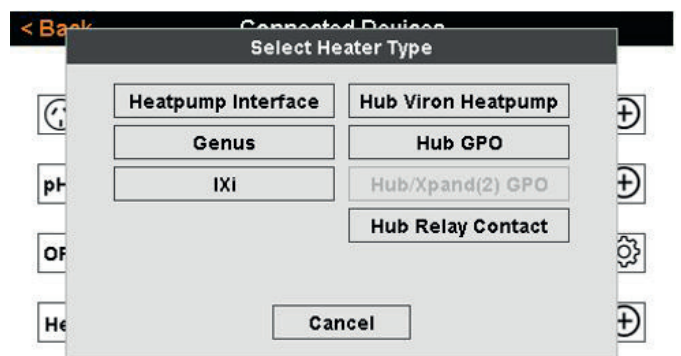

- On this screen you can choose how you wish to control the heater.
- "Heat Pump Interface" and "Genus" uses the chlorinator RJ12 connector.
- "IXI" uses the chlorinator RS485 connector.

- “Hub Viron Heatpump” uses the Hub RJ45 connector and an “Ethernet” cable directly to the heat pump.
- “Hub GPO” uses GPO1 to turn the power on or off to the heater.
- “Hub Relay Contact” uses the hub “Heater” connector. (See Appendix 1 for wiring details.)

## 4.2 Configuration and Setup

After pairing all of your Halo devices, they must be configured.

1. Press the “settings” icon on the “HOME” page of the chlorinator.



2. Press the “INSTALL” Icon in the top ribbon of the “Settings” page of the chlorinator.

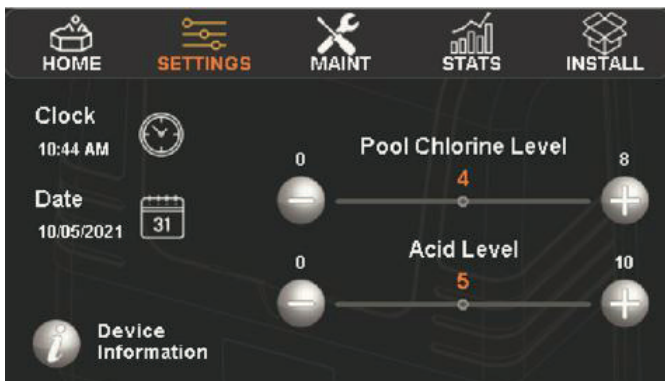

3. Press “Configure” in the “Equipment Configuration” area on the Install page.

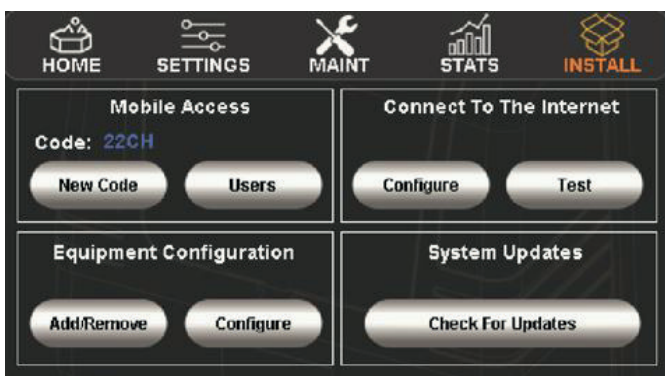

The list that is generated is used to describe how you wish to use the equipment.

For example:

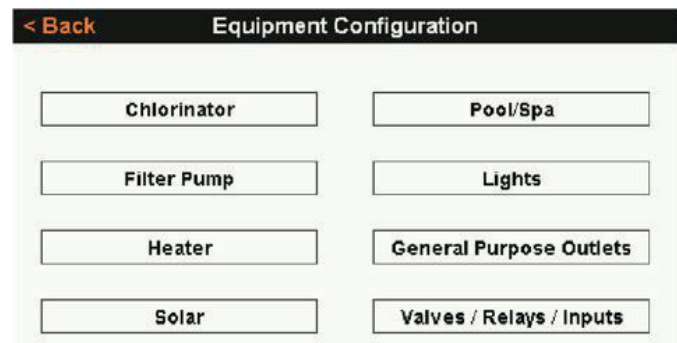

- If you are installing Lights, what brand of lights are they, do you want to use timers to control them?
- The General Purpose Outlets (GPO’s) can be named using this screen.
- If you are configuring a heater, and you wish to use a separate heater pump for that heater, name the GPO as “Heater Pump” as above and then configure the heater to use the heater pump.
- If you are using valves or relay, press the “Configure” button and then press “Valves/Relays/Inputs”.

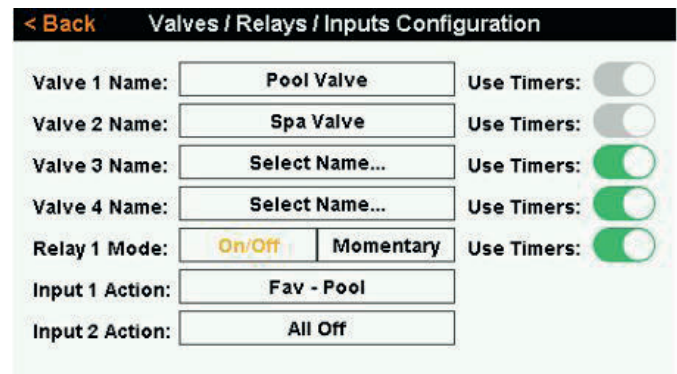

By default valve 1 and valve 2 are dedicated to pool and spa valves. (and can’t use timers).

If they are required for a different purpose, they can be re-named by pressing on their existing name and choosing another name. (Valves 3 & 4 can be named in a similar fashion.)

Input 1 and 2 can be assigned to activate a favourite on the chlorinator or “All Off or “All Auto”. (See the Halo Chlor manual and configure and name the favourites prior to assigning them to an input.) See Appendix 2 for more information.

Relay 1 can be configured to give a “Momentary” pulse (in which case it can’t use timers) or to provide an on/off action. See Appendix 2 for more information.

### 4.3 Unpairing from a Halo Chlor

Connected devices are shown in the “Connected Devices” list and have a “Settings” Icon on the RHS of the button.



Press the button of such a connected device to display a window that allows you to delete, edit, or replace the connected device.

If you no longer require a device in the system, use the “Delete” button to delete it.

If you wish to replace a connected device with a newer one, use the “Replace” button. If “Replace” is selected then the settings of the old device will be used for the new device. If you delete a device and then choose to reinstall it, you will need to configure the new device.

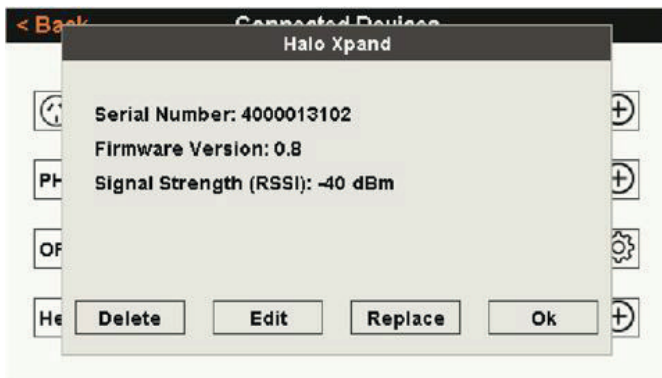

## Section 5. Control using the Halo Chlor

### 5.1 Manual Control

All of the functions of the Halo Hub can be controlled using the icons in the top ribbon of the Halo Chlor display. (Icons will only appear in the top ribbon if appropriate devices have been configured.)

Press the icons, lights, heater, solar etc., to control these devices manually.

Other functions such as cleaning pumps, blowers, etc., can be controlled using the “Others” icon in the top ribbon of the display.

### 5.2 Timer Control

Timer control is accessed by pressing the “TIMERS” icon in the top ribbon of the Halo Chlor display.

There are two groups of timers available: equipment and lighting. The duration of each timer is shown graphically on the right hand side of the screen.



1. Press the “Equipment” or “Lighting” timers button to display the available timers.
2. Press the timer you wish to adjust.

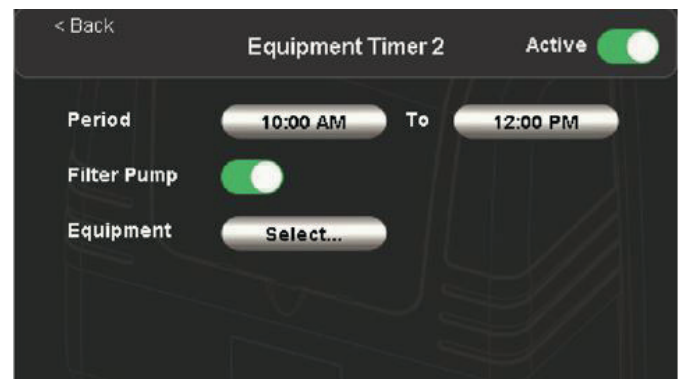

3. When the timer is opened up you can adjust the time period, select other equipment to control etc by pressing on the appropriate button (or sliding the appropriate slider).



**NOTE:** Refer to the Halo Chlor manual for more detailed information.

## Section 6. Control with the Chlorinator

### Halo Chlor App

Manual and timer control using the Halo Chlor App is identical to controlling these functions through the Halo Chlorinator (although icon images may vary).

The Halo Hub is controlled through the Halo Chlor App. The app can be loaded onto multiple mobile devices, however you can only pair one device at a time. You will need to re-pair if changing devices.

Follow the instructions located in the Halo Chlor manual to install and control.



## Section 7. Regular Maintenance

The controller is vented to allow the electronics to cool during extreme warm temperatures. During cooler months, ants and other insects can be attracted to the warm, dry environment inside the enclosure.

1. Turn mains power OFF.
2. Spray a surface insecticide on the surfaces surrounding the controller.
3. Repeat every three months or as necessary.

## Section 8. Troubleshooting

PROBLEM	SOLUTION
If a GPO isn't working, it could be disabled.	Navigate to settings>equipment. Configure add/remove>select device>edit> toggle the outlet on.

## Section 9. Appendices

### 9.1 Appendix 1:

#### Heater control through the "Heater" connector

The "Heater" connector is used to control heaters that can't be controlled using the RJ12, RS485 (on the Halo Chlor) or the RJ45 connector on the Halo Hub.

The heater connector consists of an input for an AstralPool thermistor as well as a low voltage relay output to control a heater. The heater connector relay is used to control a heater by opening and closing the "flow circuit" or "firemans switch" on the heater. (Refer to your heater's documentation on how/where to make this connection.)

The heater relay is setup using "Settings/Install" and then in "Equipment Configuration", pressing "Add/Remove" and then selecting "Heater". Finally, select "Hub Relay Contact" as the heater type.

The heater then needs to be configured using "Settings/Install" and then in "Equipment Configuration", pressing "Configure" and then "Heater". On this screen, you can then choose if this heater uses the "Filter Pump" or "Heater Pump" (if installed).

If the filter pump is used, then the water temperature thermistor that this heater uses must be connected to the Halo Chlor.

If a pump other than the filter pump is used, then the water temperature thermistor that this heater uses must be connected to the heater connector on the Halo Hub.

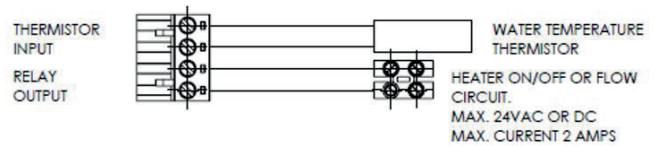

Figure 4.

The heater connector relay is a low voltage relay, so the maximum voltage through the relay is 24 volts AC or DC. The maximum current through the circuit is 2 Amps.

## 9.2 Appendix 2:

### Input 1 & 2 and relay 1 control through the "Automation" connector

The "Automation" connector is used to allow a home automation system or manual switches to control the chlorinator system.

The automation connector consists of two switchable inputs as well as a low voltage relay output. The inputs are both controlled as "Favourites" and the relay output can either be coupled to a "Favourite" or used as a general output on the Halo Chlor.

The 2 inputs can be assigned to any active favourite. Typically, one of the inputs would be assigned to a commonly used favourite e.g., "Spa at Night" and then the other input would be used to return the system to auto mode through the "All Auto" favourite.

The relay output can also be linked to a favourite as an output. An example of this, you could nominate the relay to be active in "All Auto", so that a home automation system knows that the pool system is in auto mode. Alternatively, you could use the relay to be active during a favourite such as "Spa at Night". In this scenario, the relay could signal the home automation system to dim the outside lights, etc.

The relay can also be used as a general output to drive other equipment (rather than being linked to a favourite). When used in this mode, the relay can be operated manually under the "Others" page in the top ribbon and can also be assigned to a timer.

Prior to setting up the automation inputs and relay, the hub needs to be installed on the system and favourites need to be setup on the Halo Chlor. To commence the installation, press "Settings/Install" and then in "Equipment Configuration", press "Add/Remove" and then select "Halo Hub". Press "Edit" to edit the configuration and then "Next" to get to the valves and Inputs screen. On this screen you can set the relay ("Relay 1") and inputs ("Input 1 and Input 2") to be enabled (green) or disabled (red). (Press OK to save and exit.)

The relay and inputs then needs to be configured using "Settings/Install" and then in "Equipment Configuration", pressing "Configure" and then "Valves/Relays/Inputs".

On this screen, you can then choose which favourites are activated by the inputs. Also on this screen, you can choose if you want the automation relay (Relay 1) to switch on momentarily when activated, or to turn from off to on when activated.

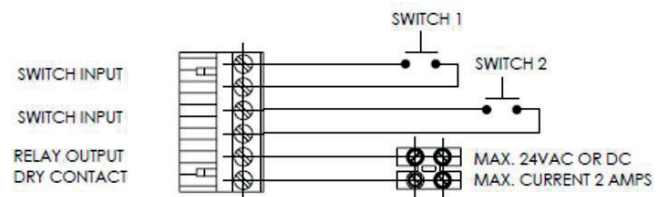

Figure 5.

The 2 inputs require a momentary signal (switch) of at least 0.5 seconds.



H0739900

**Fluidra Group Australia Pty Ltd**

219 Woodpark Road  
Smithfield NSW 2164, Australia  
1 300 186 875

[www.astralpool.com.au](http://www.astralpool.com.au)